



Pekos[®]

V A L V E S



3 & 4 way
Ball valves

ANSI

DIN

Standard construction materials

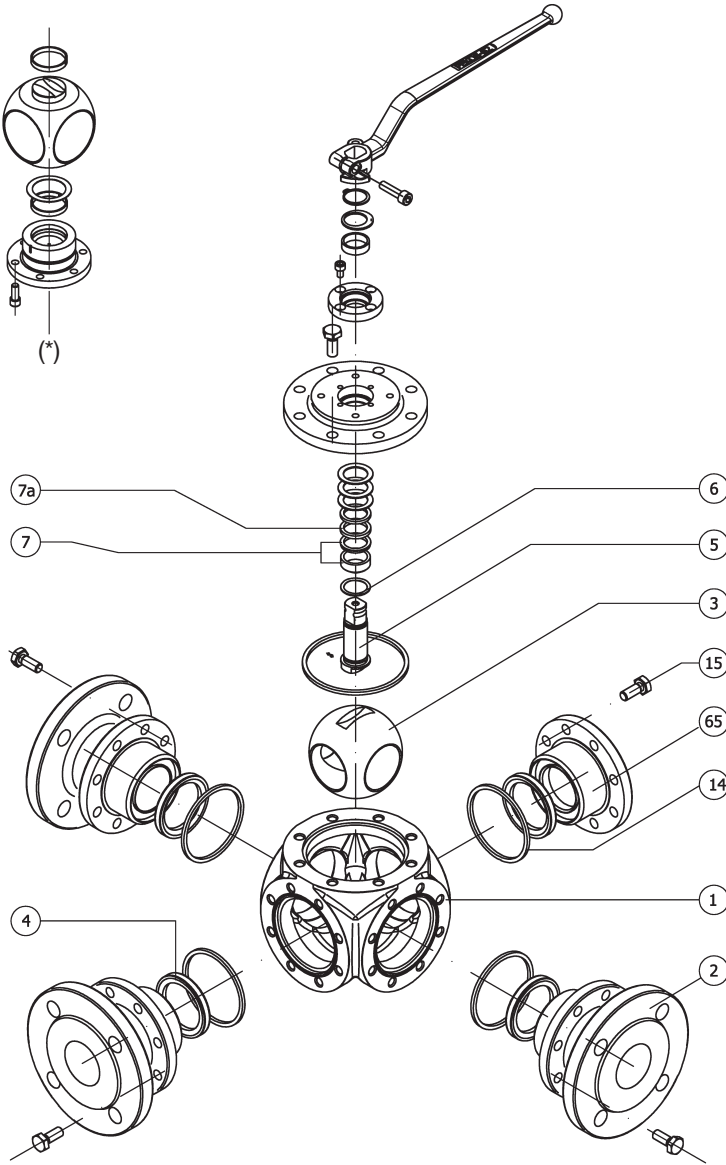

Item	Description	Qty	DIN		ANSI	
			Fig.Z84TTT	Fig.Z86TTT	Fig.Z684TTT	Fig.Z686TTT
1	Body	1	1.0619	1.4408	A 216 WCC	A351 CF8M
2	End cap	3	1.0619	1.4408	A 216 WCC	A351 CF8M
3	Ball	1	1.4408		A351 CF8M	
4	Seats	4	PTFE (T) PTFE + FG (R) PTFE + CG (S)			
5	Stem	1	1.4401		AISI 316	
6	Stem seal	1	PTFE + FG			
7	Packing 1	1	PTFE			
7a	Packing 2	1	Graphite			
14	Body seal	4	PTFE			
15	Body bolt	-	A2-70	A4-70	A193 B7 M	A193 B8M
65	Blind end	1	1.0619		A 216 WCC	A351 CF8M

* Guided ball valves PN 25/40/ Class 300 bigger than DN 100 (4").
Also valves PN 100/Class 600 bigger than DN 40 (1 1/2").

Available configurations

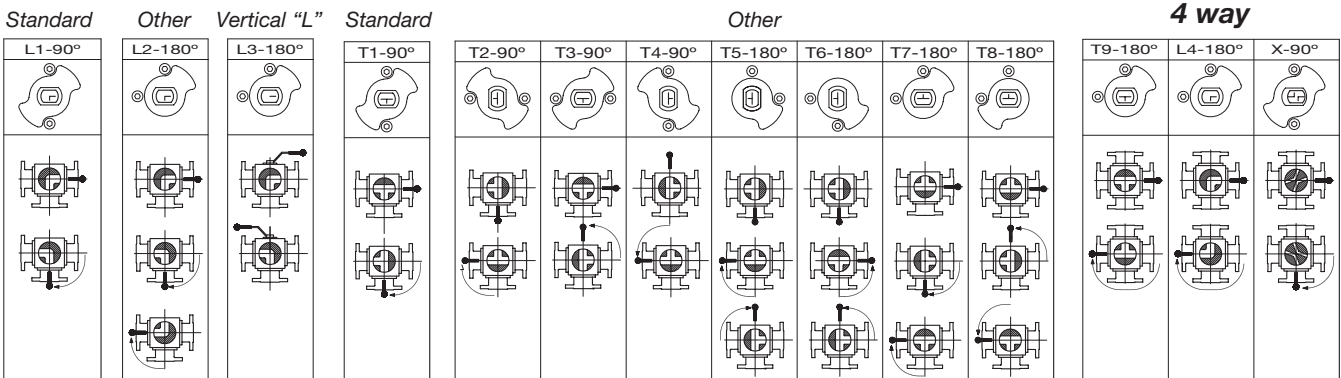

Dimensions

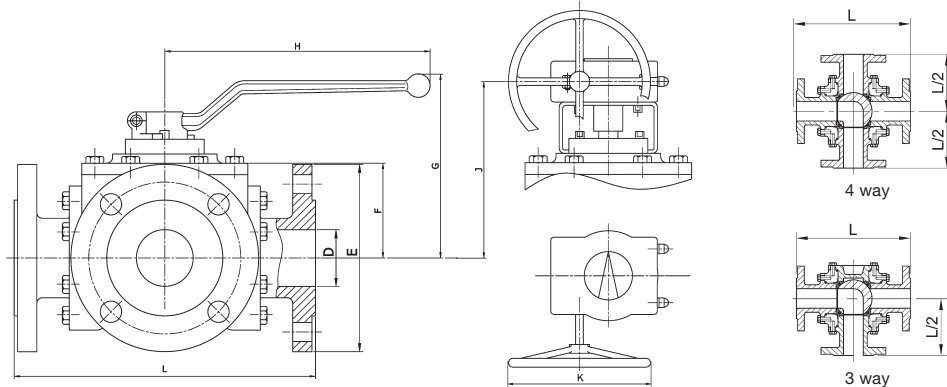

DIN PN16-40-100*

DN	D	E			ISO5211		L		F		G		H	J		K	Weight (Kg)					
		16	40	100	16/40	100	16/40	100	16/40	100	16/40	100		Valve			Valve + Gear Box					
		16	40	100	16	40	100	16	40	100	16	40		100	16		40	100				
25	25	115	115	140	F05	F05	230	230	67	58	124	115	185	-	-	-	12	13	23	-	-	-
40	40	150	150	170	F07	F07	260	260	82	88	147	154	293	170	176	250	22	25	36	25	27	38
50	50	165	165	195	F07	F07	300	300	90	118	155	193	293	178	206	250	29	31	51	32	34	53
65	65	185	185	220	F10	F10	340	340	109	111	190	216	350	241	243	250	47	50	79	50	53	81
80	80	200	200	230	F12	F12	380	380	132	151	229	248	740	241	271	250	70	75	107	73	78	117
100	100	220	235	265	F12	F12	430	430	147	155	250	258	740	268	275	315	102	112	184	112	122	132
150	150	285	300	355	F14	F14	480	550	216	229	310	313	750	356	351	400	178	192	394	196	210	411
200	200	340	375	430	F14	F16	600	650	258	295	-	-	-	398	443	500	301	325	706	319	343	732
250	250	405	450	505	F14	F16	775	775	372	330	-	-	-	542	485	500	555	600	1120	582	627	1142
300	300	460	515	585	F16	F25	850	900	395	400	-	-	-	570	655	600	754	815	1496	794	855	1528
350	334	520	580	-	F25	-	1025	-	460	-	-	-	-	595	-	600	1179	1590	-	3640	1626	-
400	385	580	660	-	F25	-	1150	-	510	-	-	-	-	665	-	600	2075	2300	-	2107	2332	-
450	436	640	685	-	F30	-	1275	-	530	-	-	-	-	790	-	800	2810	3230	-	2866	3286	-
500	487	715	755	-	F30	-	1400	-	550	-	-	-	-	810	-	800	3570	3790	-	3640	3860	-

* Ratings PN 10/25/63 can be supplied upon request.

ANSI Class 150-300-600

NPS	D	E			ISO5211		L		F		G		H	J		K	Weight (Kg)					
		150	300	600	150/300	600	150/300	600	150/300	600	150/300	600		Valve			Valve + Gear Box					
		150	300	600	150	300	600	150	300	600	150	300		600	150		300	600				
1"	25	108	124	124	F05	F05	230	230	67	58	124	115	185	-	-	--	12	13	22	-	-	-
1 1/2"	40	127	156	165	F05	F05	260	260	82	88	147	154	293	170	176	250	23	25	36	25	27	38
2"	50	152	165	165	F07	F07	290	300	90	118	155	193	293	178	206	250	29	31	51	32	34	53
2 1/2"	65	178	190	190	F10	F10	340	340	340	135	190	216	350	241	243	250	47	50	79	50	53	81
3"	80	190	210	210	F12	F12	380	380	132	151	229	248	740	241	271	250	70	75	107	73	78	117
4"	100	229	273	273	F12	F12	430	430	147	155	250	258	740	268	275	315	102	112	184	112	122	132
6"	150	280	318	356	F14	F14	490	550	216	229	310	313	750	356	351	400	178	192	394	196	210	411
8"	200	343	381	419	F14	F16	600	650	258	295	-	-	-	398	443	500	301	325	706	319	343	732
10"	250	406	445	508	F14	F16	775	775	372	330	-	-	-	542	485	500	555	600	1120	582	627	1142
12"	300	483	521	559	F16	F25	850	900	395	400	-	-	-	570	655	600	754	815	1496	794	855	1528
14"	334	533	584	-	F25	-	1025	-	460	-	-	-	-	595	-	600	1179	1590	-	1215	1626	-
16"	385	597	648	-	F25	-	1150	-	510	-	-	-	-	665	-	600	2075	2300	-	2107	2332	-
18"	436	635	710	-	F30	-	1275	-	530	-	-	-	-	790	-	800	2810	3230	-	2866	3286	-
20"	487	699	775	-	F30	-	1400	-	550	-	-	-	-	810	-	800	3570	3790	-	3640	3860	-

Top Flange ISO 5211

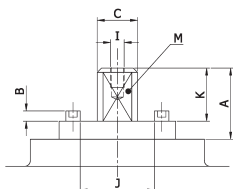

ISO 5211	F05	F7	F10	F12	F14	F16	F25	F30
M (e/c)	14	17	22	27	36	46	55	75
C	18	22	28	36	48	60	72	100
B	6	9	11	13	15	-	-	-
K	17	20	22	35	40	60	70	80
A	20	30	40	50	63	73	83	83
J	24	34	43	52	62	-	-	-
I	M4	M6	M8	M8	M10	M10	M10	M10

Break away torques (Nm)

DN	25	40	50	65	80	100	150	200	250	300	350	400	450	500
PN16	26	58	66	102	132	192	510	900	1400	2100	3150	4725	7080	10630
PN40	34	80	110	190	273	420	675	1210	1580	2150	3710	4980	7030	11690
PN 100	60	130	160	295	430	711	1530	2470	3160	3760	-	-	-	-

NPS	1"	1 1/2"	2"	2 1/2"	3"	4"	6"	8"	10"	12"	14"	16"	18"	20"
Class 150	28	60	68	105	145	198	520	950	1500	2320	3480	5280	7050	10575
Class 300	35	90	110	205	301	425	680	1220	1620	2220	4050	5875	9112	13670
Class 600	60	130	160	295	430	711	1530	2470	3160	3760	-	-	-	-

Torque values have been measured ΔP at maximum rating at room temperature with PTFE seats . The "S" and "R" seats must increase these values by 30%.

Kv values (m³/h)

“L” Port

DN	25	40	50	65	80	100	150	200	250	300	350	400	450	500
NPS	1"	1 1/2"	2"	2 1/2"	3"	4"	6"	8"	10"	12"	14"	16"	18"	20"
Kv	25	60	85	148	295	380	750	1300	1955	2830	4096	5325	7182	9640

Flow direction

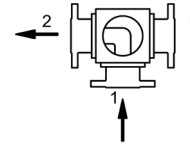

“T” and “X” Port

DN		25	40	50	65	80	100	150	200	250	300	350	400	450	500	
NPS		1"	1 1/2"	2"	2 1/2"	3"	4"	6"	8"	10"	12"	14"	16"	18"	20"	
Kv	(A)	PORT 2	20	51	75	136	215	340	705	905	1300	1956	2940	3850	5005	8320
	(B)	PORT 1	23	60	190	141	338	380	815	995	1453	2100	2520	3025	3780	4725
		PORT 2	58	160	270	510	812	1380	2650	4603	5230	6100	7625	9530	11520	14320
	(C)	PORTS 2/3	24	58	85	144	218	340	767	1150	1840	2860	3575	4460	5580	6980
	(D)	PORT 2	60	170	292	532	858	1425	2800	4820	5850	6734	8410	10510	13000	16420
(E)	PORTS 2/4	16	39	60	101	154	242	542	867	1430	2410	4060	5060	6830	9540	

Flow direction

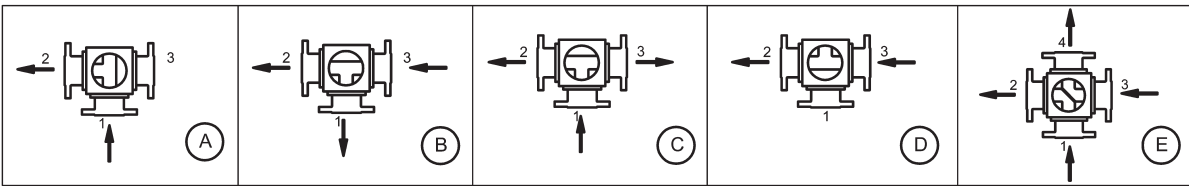

Pressure - Temperature limitations

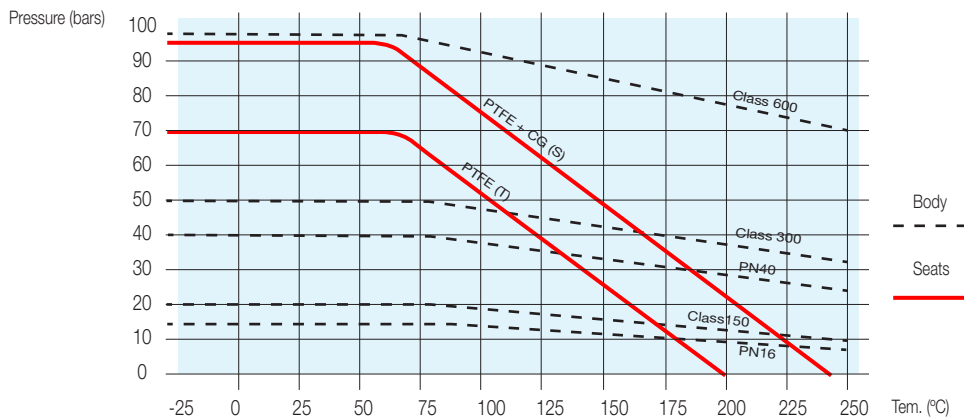

www.pekos.es

Sales & Headquarters:
 Rec del Molinar, 9 - P.I. El Circuit
 08160 Montmeló (Barcelona) - Spain

Factory:
 Bildosola industrialdea
 48142 Artea (Vizcaya) - Spain

Tel.: (+34) 93 568 92 56

pekos@pekos.es

Member of Pekos group